



Montaje sin tornillos
Montage sans vis ni écrous
Aufbau ohne Schrauben



Se recomienda usar martillo de goma
Recommandé utiliser un marteau en caoutchouc
Empfohlen wird ein Gummihammer



Se recomienda el uso de guantes
Nous recommandons l'utilisation de gants
Verwendung von Handschuhen wird empfohlen

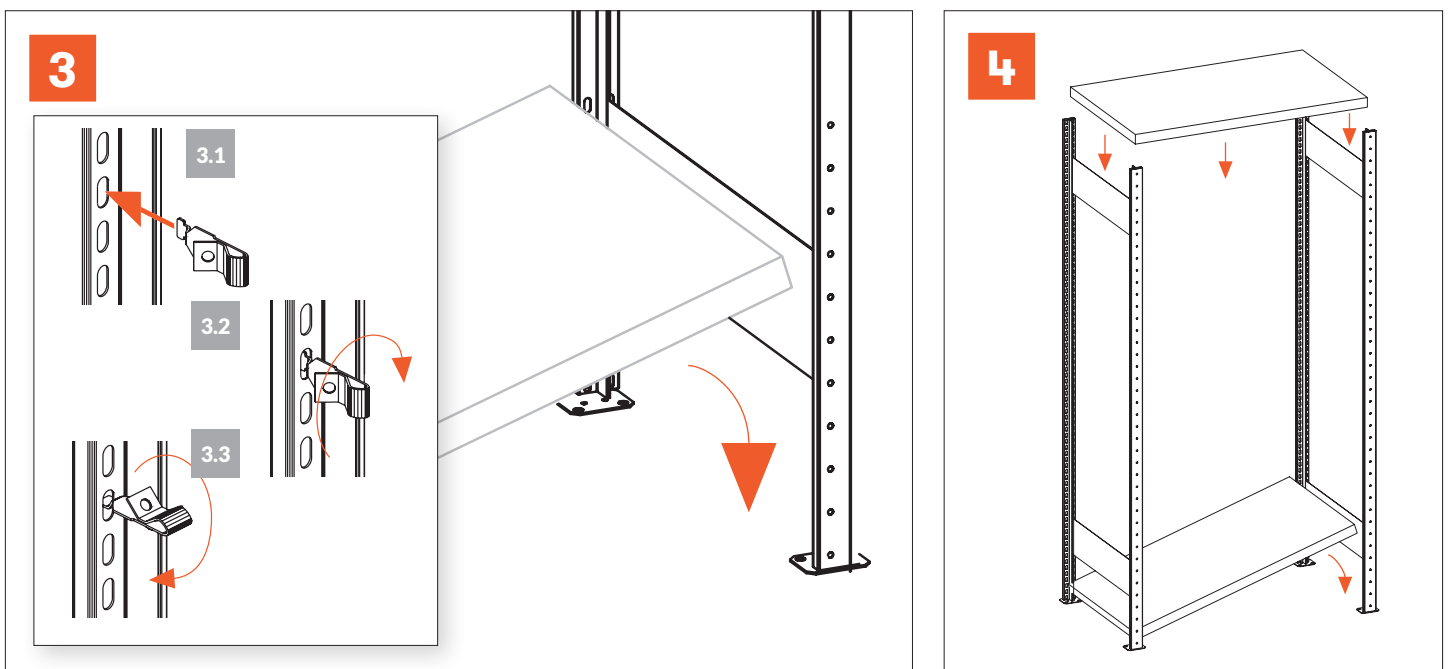
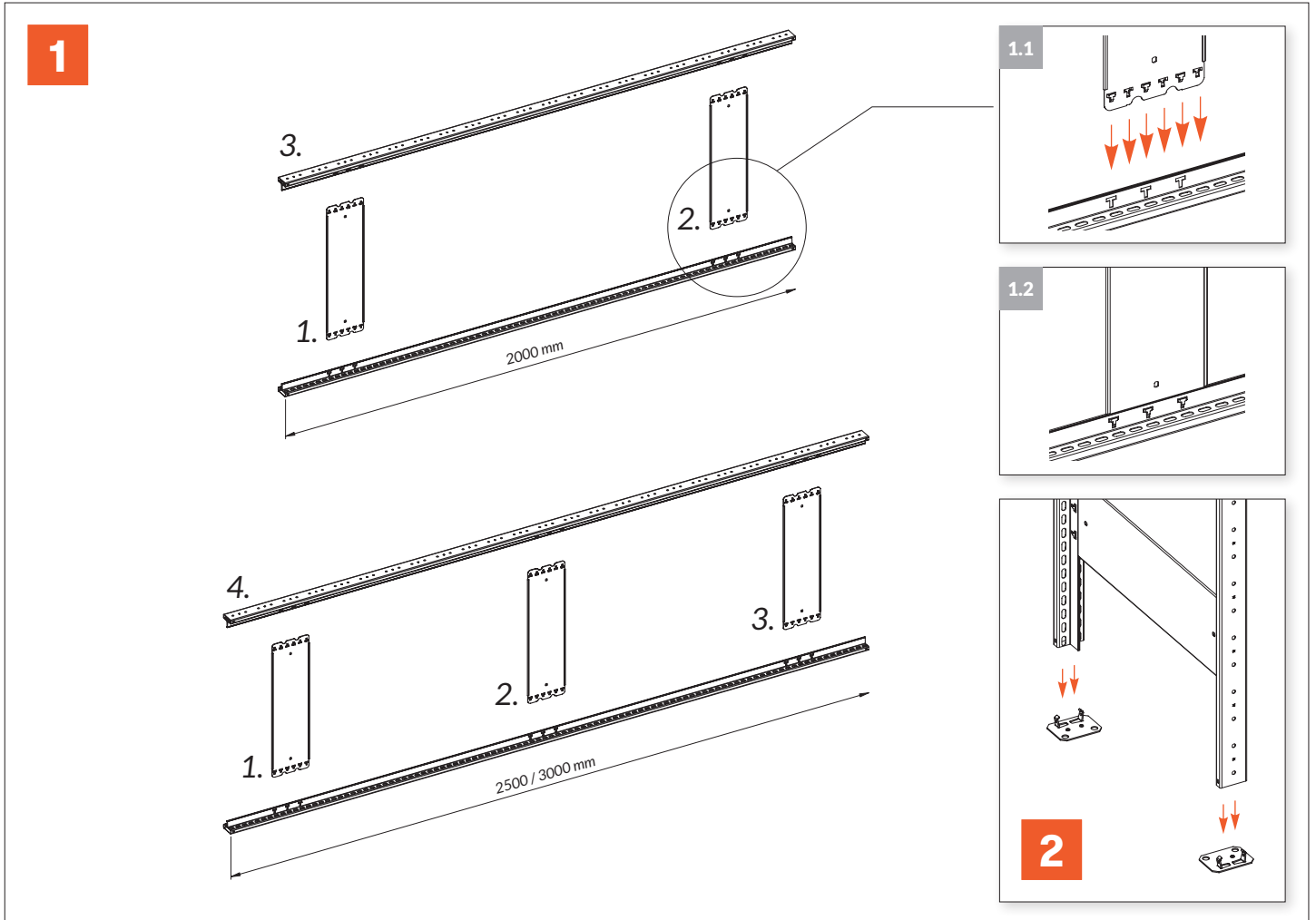

5

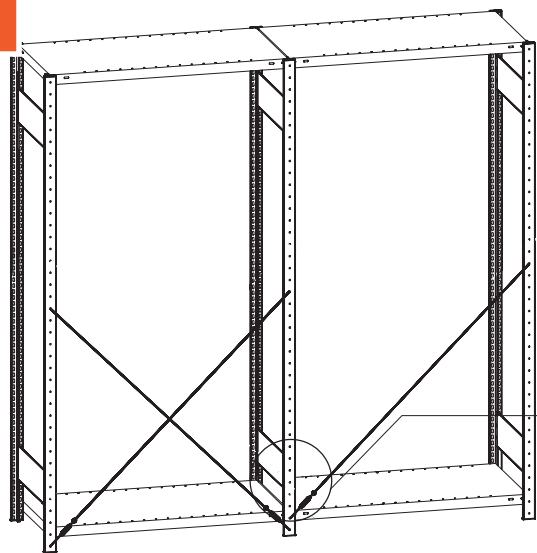

MÓDULO INICIAL
MODULE DE DÉPART
GRUNDREGAL

MÓDULO ADICIONAL
MODULE SUPPLÉMENTAIRE
ANBAUREGAL

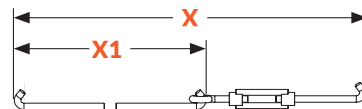
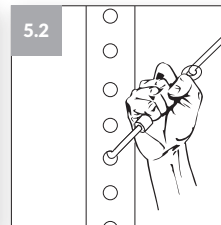
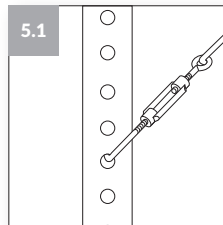
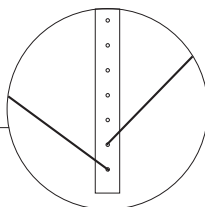

| L | X | X1 |
|---------|---------|---------|
| 1000 mm | 1303 mm | 1186 mm |
| 1300 mm | 1532 mm | 1415 mm |
| 1500 mm | 1697 mm | 1580 mm |

B

(H) 2000 X

(L) 1000 / 1300 / 1500 mm

(H) 2500 / 3000 X

(L) 1000 / 1300 / 1500 mm

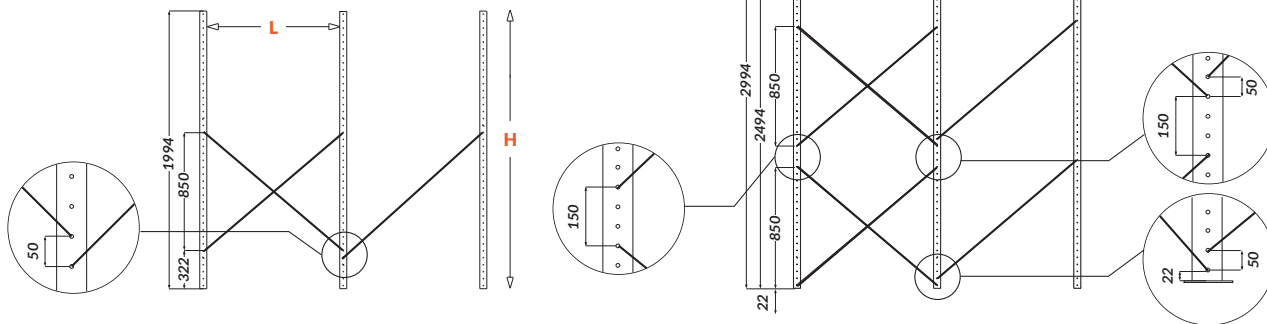

C

MÓDULO INICIAL
MODULE DE DÉPART
GRUNDREGAL

MÓDULOS ADICIONALES
MODULES SUPPLÉMENTAIRES
ANBAUREGALE

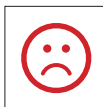
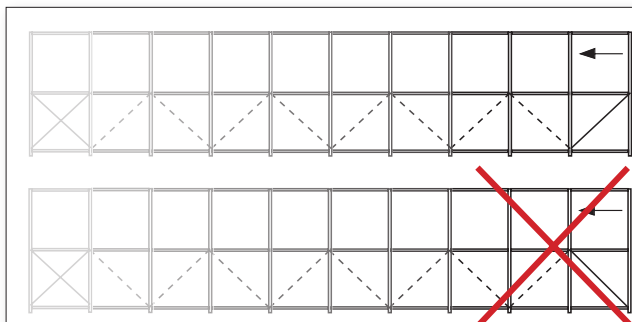
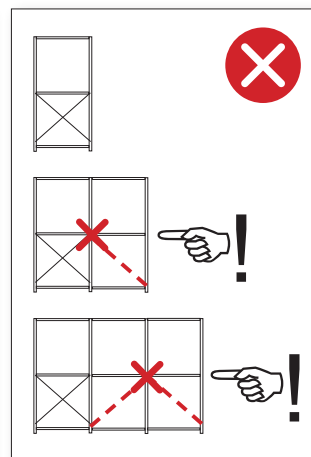
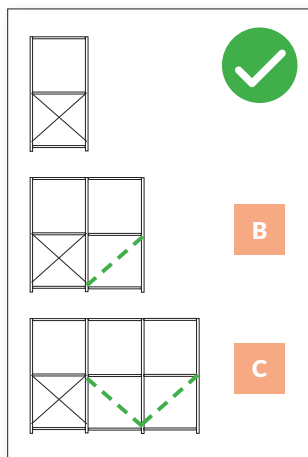
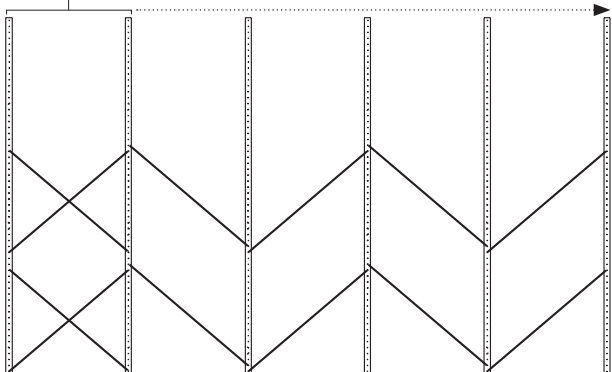

¡ATENCIÓN!

El tensor diagonal, siempre debe ir colocado de abajo a arriba en el último módulo adicional.

ATTENTION!

Le tenseur diagonal doit toujours être installé du bas vers le haut sur le dernier module supplémentaire.

ACHTUNG!

Die diagonale Verstrebung muß immer von unten nach oben im letzten Anbauregal angebracht werden.